

Data sheet | Item number: 765-1505/100-000

8-channel digital input/output; EtherNet/IP; DC 24 V / 2.0 A; 8xM8 connection; SlimLine

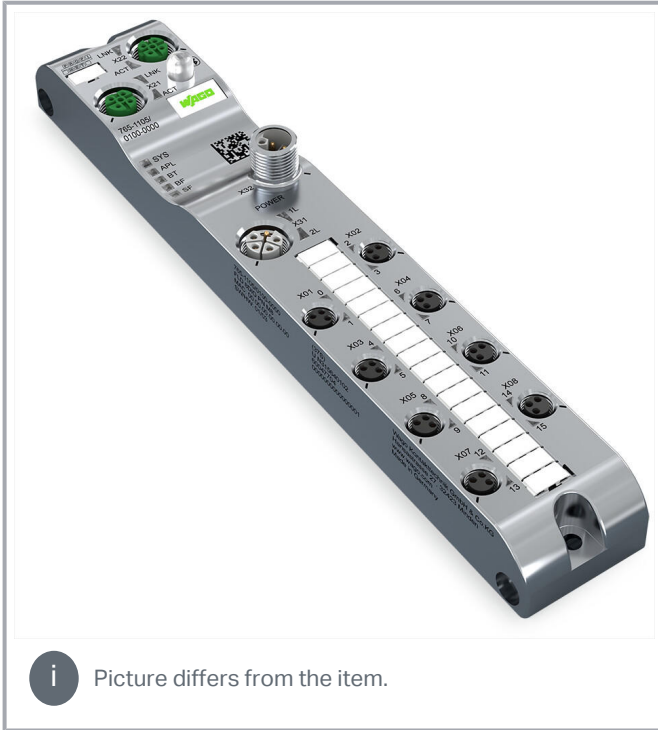

www.wago.com/765-1505/100-000



i Picture differs from the item.

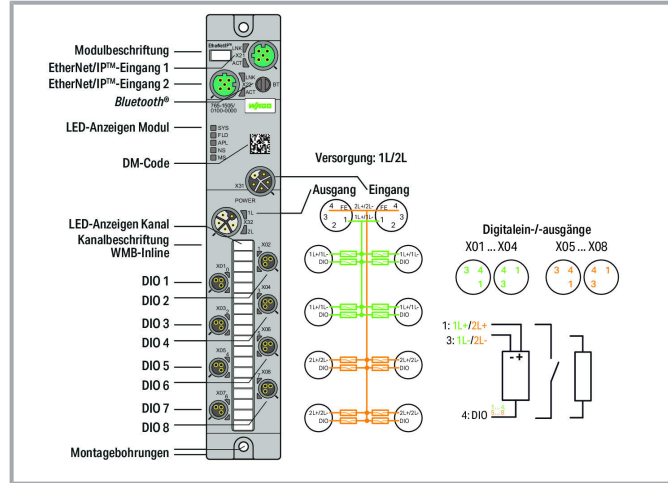

Data Technical data

Fieldbus

Communication

EtherNet/IP™
BOOTP, DHCP, DLR

EtherNet/IP™
BOOTP, DHCP, DLR

Connection technology: communication/fieldbus	2 x D-coded M12; 4-pole
Interface standard	10BASE-T/100BASE-TX; potential-free
Autonegotiation; autocrossover	yes

Device Functions

Parameters

Input filter

Subject to changes. Please also observe the further product documentation!

WAGO GmbH & Co. KG
Hansastr. 27
32423 Minden
Phone: +49571 887-0 | Fax: +49571 887-169
Email: info.de@wago.com | Web: www.wago.com

Do you have any questions about our products?
We are always happy to take your call at +49 (571) 887-44222.



	Output current Temperature
Diagnostics	Undervoltage; Overcurrent; Overload; Overtemperature
Device functions	Bluetooth® Bluetooth® OPC UA Server
Visualization	Android/iOS app Webserver

Digital inputs/outputs

Number of digital inputs	8
Number of digital outputs	8
Connection technology: inputs/outputs	8 x M8; 3-pole
Voltage signal type	24 VDC
Input characteristic	High-side switching
Input filter	0.2 ... 20 ms
Input characteristic	Type 3, per IEC 61131-2
Output current (per channel)	2 A (typ.) for DO
Supply current per port	1L/2L: 4 A (max.)

Module Power Supply

Connection technology: supply	2 x L-coded M12; 5-pole
Supply voltage	24 VDC (18 ... 31.2 V); 1L/2L
Power consumption (max.)	16000 mA
Power consumption (note)	per supply line; overload- and short-circuit-protected
Reverse voltage protection	Yes

Geometrical Data

Width	35 mm / 1.378 inch
Height	30 mm / 1.181 inch
Depth	210 mm / 8.268 inch

Mechanical Data

Weight	390 g
Conformity marking	CE

Subject to changes. Please also observe the further product documentation!

Environmental Requirements

Surrounding air temperature (operation)	-25 ... +70 °C
Surrounding air temperature (storage)	-40 ... +80 °C
Protection type	IP67
Protection class	III per EN 61140, IEC 61140, VDE 0140-1
Operating altitude	0 ... 2000 m
Pollution degree (5)	3 per EN 60664-1
Overvoltage category	II (EN 60664-1)
Relative humidity (without condensation)	95 %
Vibration resistance	5g per IEC 60068-2-6
Shock resistance	Short-term: 50g/11 ms/half-sine per IEC 60068-2-27; Long-term: 30g/6 ms/half-sine per IEC 60068-2-29
EMC immunity to interference	per EN 61000-6-2
EMC emission of interference	per EN 61000-6-4

Commercial data

PU (SPU)	1 Pieces
Packaging type	BOX
Country of origin	DE
GTIN	4055144009972
Customs tariff number	85371098990

Required accessories

Marking accessories

Marking strip		
---------------	--	--



Item no.: 2009-110

Marking strips; for Smart Printer; on reel; not stretchable; plain; snap-on type; white

www.wago.com/2009-110

Marker		
--------	--	--



Item no.: 2009-115

WMB-Inline; for Smart Printer; 1500 pieces on roll; stretchable 5 - 5.2 mm; plain; snap-on type; white

www.wago.com/2009-115

Tool		
------	--	--

Assembly tool		
---------------	--	--

Item no.: 206-701

Torque wrench M8 and M12; Assembly kit

www.wago.com/206-701

Cover		
-------	--	--

Subject to changes. Please also observe the further product documentation!

WAGO GmbH & Co. KG

Hansastr. 27

32423 Minden

Phone: +49571 887-0 | Fax: +49571 887-169

Email: info.de@wago.com | Web: www.wago.com

Do you have any questions about our products?

We are always happy to take your call at +49 (571) 887-44222.



Cover

Item no.: 756-8102 M12 protective cap; for unused sockets	www.wago.com/756-8102
Item no.: 756-8103 M12 protective cap; for unused plugs	www.wago.com/756-8103
Item no.: 756-8101 M8 protective cap; for unused sockets	www.wago.com/756-8101

Optional accessories

Cables and pluggable connectors

Sensor/actuator cable

Item no.: 756-5501/030-020 Sensor/Actuator cable; M12A socket; straight; M8 plug; straight; 3-pole; Length: 2 m	www.wago.com/756-5501/030-020
 Item no.: 756-5502/030-010 Sensor/Actuator cable; M12A socket; straight; M8 plug; angled; 3-pole; Length: 1 m	www.wago.com/756-5502/030-010
 Item no.: 756-5502/030-020 Sensor/Actuator cable; M12A socket; straight; M8 plug; angled; 3-pole; Length: 2 m	www.wago.com/756-5502/030-020
Item no.: 756-5503/030-010 Sensor/Actuator cable; M12A socket; angled; M8 plug; straight; 3-pole; Length: 1 m	www.wago.com/756-5503/030-010
Item no.: 756-5503/030-020 Sensor/Actuator cable; M12A socket; angled; M8 plug; straight; 3-pole; Length: 2 m	www.wago.com/756-5503/030-020
Item no.: 756-5111/030-015 Sensor/Actuator cable; M8 plug; straight; 3-pole; Length: 1.5 m	www.wago.com/756-5111/030-015
Item no.: 756-5111/030-050 Sensor/Actuator cable; M8 plug; straight; 3-pole; Length: 5 m	www.wago.com/756-5111/030-050
Item no.: 756-5111/030-100 Sensor/Actuator cable; M8 plug; straight; 3-pole; Length: 10 m	www.wago.com/756-5111/030-100
Item no.: 756-5112/030-100 Sensor/Actuator cable; M8 plug; angled; 3-pole; Length: 10 m	www.wago.com/756-5112/030-100

Subject to changes. Please also observe the further product documentation!

Item no.: 756-5112/030-015

Sensor/Actuator cable; M8 plug; angled; 3-pole; Length: 1.5 m

www.wago.com/756-5112/030-015

Item no.: 756-5112/030-050

Sensor/Actuator cable; M8 plug; angled; 3-pole; Length: 5 m

www.wago.com/756-5112/030-050

Item no.: 756-5201/030-010

Sensor/Actuator cable; M8 socket; straight; M8 plug; straight; 3-pole; Length: 1 m

www.wago.com/756-5201/030-010

Item no.: 756-5201/030-020

Sensor/Actuator cable; M8 socket; straight; M8 plug; straight; 3-pole; Length: 2 m

www.wago.com/756-5201/030-020

Item no.: 756-5202/030-020

Sensor/Actuator cable; M8 socket; straight; M8 plug; angled; 3-pole; Length: 2 m

www.wago.com/756-5202/030-020

Item no.: 756-5202/030-010

Sensor/Actuator cable; M8 socket; straight; M8 plug; angled; 3-pole; Length: 1 m

www.wago.com/756-5202/030-010

Item no.: 756-5203/030-010

Sensor/Actuator cable; M8 socket; angled; M8 plug; straight; 3-pole; Length: 1 m

www.wago.com/756-5203/030-010

Item no.: 756-5203/030-020

Sensor/Actuator cable; M8 socket; angled; M8 plug; straight; 3-pole; Length: 2 m

www.wago.com/756-5203/030-020



Item no.: 756-5204/030-020

Sensor/Actuator cable; M8 socket; angled; M8 plug; angled; 3-pole; Length: 2 m

www.wago.com/756-5204/030-020



Item no.: 756-5204/030-010

Sensor/Actuator cable; M8 socket; angled; M8 plug; angled; 3-pole; Length: 1 m

www.wago.com/756-5204/030-010

Item no.: 756-5501/030-010

Sensor/Actuator cable; M12A socket; straight; M8 plug; straight; 3-pole; Length: 1 m

www.wago.com/756-5501/030-010

Item no.: 756-5504/030-010

Sensor/Actuator cable; M12A socket; angled; M8 plug; angled; 3-pole; Length: 1 m

www.wago.com/756-5504/030-010

Item no.: 756-5504/030-020

Sensor/Actuator cable; M12A socket; angled; M8 plug; angled; 3-pole; Length: 2 m

www.wago.com/756-5504/030-020

Configurable connectors

Subject to changes. Please also observe the further product documentation!

WAGO GmbH & Co. KG

Hansastr. 27

32423 Minden

Phone: +49571 887-0 | Fax: +49571 887-169

Email: info.de@wago.com | Web: www.wago.com

Do you have any questions about our products?

We are always happy to take your call at +49 (571) 887-44222.

Item no.: 756-9102/030-000

Fitted pluggable connector; 3-pole; M8 plug, straight; IDC technology

www.wago.com/756-9102/030-000



Item no.: 756-9105/030-000

Fitted pluggable connector; 3-pole; M8 plug, right angle; IDC technology

www.wago.com/756-9105/030-000



Item no.: 756-9711/050-000

Fitted pluggable connector; 5-pole, shielded; M12 socket, straight; IDC technology

www.wago.com/756-9711/050-000



Item no.: 756-9701/050-000

Fitted pluggable connector; 5-pole, shielded; M12 plug, straight; IDC technology

www.wago.com/756-9701/050-000

Configurable shielded connectors

Item no.: 756-9501/060-000

Fitted pluggable connector; 5-pole, shielded; M12 plug, straight, D-coded; Spring

www.wago.com/756-9501/060-000

Item no.: 756-9501/040-000

Accessories; M12 plug, right angle; 4-pole

www.wago.com/756-9501/040-000

Power cable



Item no.: 756-3501/050-075

Power cable; M12L socket; straight; 5-pole; Length: 7.5 m

www.wago.com/756-3501/050-075



Item no.: 756-3501/050-100

Power cable; M12L socket; straight; 5-pole; Length: 10 m

www.wago.com/756-3501/050-100



Item no.: 756-3501/050-150

Power cable; M12L socket; straight; 5-pole; Length: 15 m

www.wago.com/756-3501/050-150



Item no.: 756-3501/050-050

Power cable; M12L socket; straight; 5-pole; Length: 5 m

www.wago.com/756-3501/050-050



Item no.: 756-3502/050-050

Power cable; M12L socket; angled; 5-pole; Length: 5 m

www.wago.com/756-3502/050-050

Subject to changes. Please also observe the further product documentation!

WAGO GmbH & Co. KG

Hansastr. 27













32423 Minden

Phone: +49571 887-0 | Fax: +49571 887-169













Email: info.de@wago.com | Web: www.wago.com

Do you have any questions about our products?

We are always happy to take your call at +49 (571) 887-44222.

	Item no.: 756-3502/050-150 Power cable; M12L socket; angled; 5-pole; Length: 15 m	www.wago.com/756-3502/050-150
	Item no.: 756-3502/050-075 Power cable; M12L socket; angled; 5-pole; Length: 7.5 m	www.wago.com/756-3502/050-075
	Item no.: 756-3502/050-100 Power cable; M12L socket; angled; 5-pole; Length: 10 m	www.wago.com/756-3502/050-100
	Item no.: 756-3503/050-075 Power cable; M12L plug; straight; 5-pole; Length: 7.5 m	www.wago.com/756-3503/050-075
	Item no.: 756-3503/050-150 Power cable; M12L plug; straight; 5-pole; Length: 15 m	www.wago.com/756-3503/050-150
	Item no.: 756-3503/050-100 Power cable; M12L plug; straight; 5-pole; Length: 10 m	www.wago.com/756-3503/050-100
	Item no.: 756-3505/050-003 Power cable; M12L socket; straight; M12L plug; straight; 5-pole; Length: 0.3 m	www.wago.com/756-3505/050-003
	Item no.: 756-3505/050-005 Power cable; M12L socket; straight; M12L plug; straight; 5-pole; Length: 0.5 m	www.wago.com/756-3505/050-005
	Item no.: 756-3505/050-020 Power cable; M12L socket; straight; M12L plug; straight; 5-pole; Length: 2 m	www.wago.com/756-3505/050-020
	Item no.: 756-3505/050-010 Power cable; M12L socket; straight; M12L plug; straight; 5-pole; Length: 1 m	www.wago.com/756-3505/050-010
	Item no.: 756-3505/050-050 Power cable; M12L socket; straight; M12L plug; straight; 5-pole; Length: 5 m	www.wago.com/756-3505/050-050
	Item no.: 756-3505/050-075 Power cable; M12L socket; straight; M12L plug; straight; 5-pole; Length: 7.5 m	www.wago.com/756-3505/050-075

Subject to changes. Please also observe the further product documentation!

	Item no.: 756-3505/050-100 Power cable; M12L socket; straight; M12L plug; straight; 5-pole; Length: 10 m	www.wago.com/756-3505/050-100
	Item no.: 756-3506/050-100 Power cable; M12L socket; angled; M12L plug; angled; 5-pole; Length: 10 m	www.wago.com/756-3506/050-100
	Item no.: 756-3506/050-075 Power cable; M12L socket; angled; M12L plug; angled; 5-pole; Length: 7.5 m	www.wago.com/756-3506/050-075
	Item no.: 756-3506/050-150 Power cable; M12L socket; angled; M12L plug; angled; 5-pole; Length: 15 m	www.wago.com/756-3506/050-150
	Item no.: 756-3501/050-020 Power cable; M12L socket; straight; 5-pole; Length: 2 m	www.wago.com/756-3501/050-020
	Item no.: 756-3502/050-020 Power cable; M12L socket; angled; 5-pole; Length: 2 m	www.wago.com/756-3502/050-020
	Item no.: 756-3503/050-020 Power cable; M12L plug; straight; 5-pole; Length: 2 m	www.wago.com/756-3503/050-020
	Item no.: 756-3503/050-050 Power cable; M12L plug; straight; 5-pole; Length: 5 m	www.wago.com/756-3503/050-050
	Item no.: 756-3504/050-020 Power cable; M12L plug; angled; 5-pole; Length: 2 m	www.wago.com/756-3504/050-020
	Item no.: 756-3504/050-050 Power cable; M12L plug; angled; 5-pole; Length: 5 m	www.wago.com/756-3504/050-050
	Item no.: 756-3504/050-075 Power cable; M12L plug; angled; 5-pole; Length: 7.5 m	www.wago.com/756-3504/050-075
	Item no.: 756-3504/050-100 Power cable; M12L plug; angled; 5-pole; Length: 10 m	www.wago.com/756-3504/050-100

Subject to changes. Please also observe the further product documentation!



Item no.: 756-3504/050-150
Power cable; M12L plug; angled; 5-pole; Length: 15 m

www.wago.com/756-3504/050-150



Item no.: 756-3505/050-150
Power cable; M12L socket; straight; M12L plug; straight; 5-pole; Length: 15 m

www.wago.com/756-3505/050-150



Item no.: 756-3506/050-003
Power cable; M12L socket; angled; M12L plug; angled; 5-pole; Length: 0.3 m

www.wago.com/756-3506/050-003



Item no.: 756-3506/050-005
Power cable; M12L socket; angled; M12L plug; angled; 5-pole; Length: 0.5 m

www.wago.com/756-3506/050-005



Item no.: 756-3506/050-020
Power cable; M12L socket; angled; M12L plug; angled; 5-pole; Length: 2 m

www.wago.com/756-3506/050-020



Item no.: 756-3506/050-010
Power cable; M12L socket; angled; M12L plug; angled; 5-pole; Length: 1 m

www.wago.com/756-3506/050-010



Item no.: 756-3506/050-050
Power cable; M12L socket; angled; M12L plug; angled; 5-pole; Length: 5 m

www.wago.com/756-3506/050-050

Adapter



Item no.: 756-9503/040-000
Accessories; 4-pole

www.wago.com/756-9503/040-000

Item no.: 756-9504/040-000
Accessories; 4-pole

www.wago.com/756-9504/040-000

ETHERNET/PROFINET cable



Item no.: 756-1202/060-200
ETHERNET cable; M12D plug; angled; 4-pole; Length: 20 m

www.wago.com/756-1202/060-200



Item no.: 756-1201/060-100
ETHERNET cable; M12D plug; straight; 4-pole; Length: 10 m

www.wago.com/756-1201/060-100

Subject to changes. Please also observe the further product documentation!



Item no.: 756-1201/060-050
ETHERNET cable; M12D plug; straight; 4-pole; Length: 5 m

www.wago.com/756-1201/060-050



Item no.: 756-1203/060-050
ETHERNET cable; M12D plug; straight; M12D plug; straight; 4-pole; Length: 5 m

www.wago.com/756-1203/060-050



Item no.: 756-1203/060-020
ETHERNET cable; M12D plug; straight; M12D plug; straight; 4-pole; Length: 2 m

www.wago.com/756-1203/060-020



Item no.: 756-1202/060-020
ETHERNET cable; M12D plug; angled; 4-pole; Length: 2 m

www.wago.com/756-1202/060-020



Item no.: 756-1201/060-200
ETHERNET cable; M12D plug; straight; 4-pole; Length: 20 m

www.wago.com/756-1201/060-200



Item no.: 756-1204/060-050
ETHERNET cable; M12D plug; angled; M12D plug; angled; 4-pole; Length: 5 m

www.wago.com/756-1204/060-050



Item no.: 756-1204/060-100
ETHERNET cable; M12D plug; angled; M12D plug; angled; 4-pole; Length: 10 m

www.wago.com/756-1204/060-100



Item no.: 756-1204/060-200
ETHERNET cable; M12D plug; angled; M12D plug; angled; 4-pole; Length: 20 m

www.wago.com/756-1204/060-200



Item no.: 756-1203/060-200
ETHERNET cable; M12D plug; straight; M12D plug; straight; 4-pole; Length: 20 m

www.wago.com/756-1203/060-200



Item no.: 756-1203/060-100
ETHERNET cable; M12D plug; straight; M12D plug; straight; 4-pole; Length: 10 m

www.wago.com/756-1203/060-100



Item no.: 756-1204/060-010
ETHERNET cable; M12D plug; angled; M12D plug; angled; 4-pole; Length: 0.1 m

www.wago.com/756-1204/060-010



Item no.: 756-1204/060-030
ETHERNET cable; M12D plug; angled; M12D plug; angled; 4-pole; Length: 3 m

www.wago.com/756-1204/060-030

Subject to changes. Please also observe the further product documentation!



Item no.: 756-1204/060-020

ETHERNET cable; M12D plug; angled; M12D plug; angled; 4-pole; Length: 2 m

www.wago.com/756-1204/060-020



Item no.: 756-1202/060-050

ETHERNET cable; M12D plug; angled; 4-pole; Length: 5 m

www.wago.com/756-1202/060-050



Item no.: 756-1202/060-100

ETHERNET cable; M12D plug; angled; 4-pole; Length: 10 m

www.wago.com/756-1202/060-100



Item no.: 756-1201/060-020

ETHERNET cable; M12D plug; straight; 4-pole; Length: 2 m

www.wago.com/756-1201/060-020

Downloads

Documentation

Manual

8-Channel Digital Input/Output; EtherNet/IP DC 24 V / 2.0 A; 8xM8 Connection; SlimLine	V 1.1.0 2021年4月20日	pdf 5.1 MB	Download
---	-----------------------	---------------	----------

System Description

WAGO I/O System Field; General Product Information		pdf 708.2 kB	Download
--	--	-----------------	----------

Runtime Software

Firmware

Ethernet/IP IO-Field 765-x5xx Firmware Download WAGO_FW0765-x5xx_V01010011_IX01.zip	V 01 2021年7月23日	zip 41.3 MB	Download
--	--------------------	----------------	----------

CAD/CAE-Data

CAD data

2D/3D Models 765-1505/100-000		URL	Download
-------------------------------	--	-----	----------

Subject to changes. Please also observe the further product documentation!



Device Files

Device Description File

750-915; EDS-Dateien for EthernetIP / Serie 750, 765 and 767	12 2021年7月9日	zip 168.4 kB	Download
Gerätebeschreibungdateien 765-45xx, 765-15xx, EtherNet/IP	V1_1_0_11	zip 74 B	Download

Environmental Product Compliance

Compliance Search

Environmental Product Compliance 765-1505/100-000 8-channel digital input/output; EtherNet/IP; DC 24 V / 2.0 A; 8xM8 connection; SlimLine	URL	Download
---	-----	----------

Installation Notes

Product family

WAGO I/O System Field
[Show all products from the family](#)

Subject to changes. Please also observe the further product documentation!